



TYRE CHANGERS accessories

LEGENDA:  Vedi listino per maggiori dettagli
 See pricelist for more details
 Siehe Preisliste für mehr Details
 Voir tarif pour plus de précisions
 Ver lista de precios para más detalles

 Montaggio in fabbrica
 Factory assembled
 Werkseitig montiert
 Montage in usine
 Montaje en fábrica

Helper  (for tilt back tyre changers)
 per smontagomme automatici

PLUS83H

Dispositivo premi-alza tallone pneumatico con braccio rotante
Air-driven helper with rotating arm
 Pneumatischer Hilfsmontagearm mit Zusatzhilfsarm
Dispositif pousse-lève talon pneumatique avec bras rotatif
 Dispositivo prensa talón neumático con brazo rotatorio



PLUS83HS

PLUS83H con disco inclinato 45°
PLUS83H with 45° tilted roller
 PLUS83H mit 45° geneigte Rolle
PLUS83H avec rouleau incliné 45°
 PLUS83H con rodillo inclinado 45°



180° Rotation

PLUS85H

Dispositivo con avanzamento pneumatico del disco
Device with pneumatic indent of the roller
 Hilfsrolle mit pneumatischer Positionierung
Dispositif avec positionnement pneumatique du rouleau
 Dispositivo con posicionamiento neumático del rodillo



Pneumatic Indent

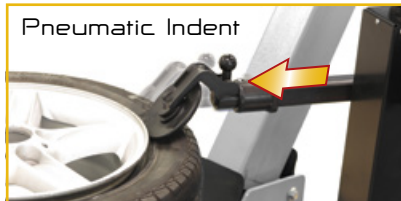

Posizionamento rullo / Easy roller indent



OPTIONS

Braccio addizionale
Additional arm
 Zusatzarm
Bras additional
 Brazo suplementar

Non possono essere abbinati fra loro.
The cannot be combined together.
 Nicht zusammen montierbar.
Ne peuvent pas être combinés ensemble.
 No se pueden combinar entre ellos.

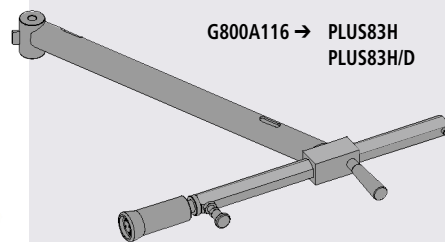

G800A116 → PLUS83H
 PLUS83H/D

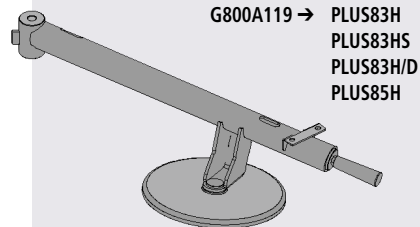

G800A119 → PLUS83H
 PLUS83HS
 PLUS83H/D
 PLUS85H

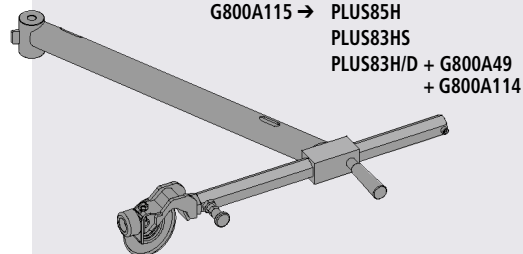

G800A115 → PLUS85H
 PLUS83HS
 PLUS83H/D + G800A49
 + G800A114

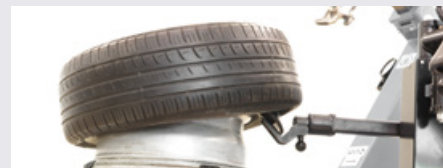

PLUS82H

Dispositivo premi-alza tallone pneumatico
Air-driver helper
 Pneumatischer Hilfsmontagearm
Dispositif pousse-lève talon pneumatique
 Dispositivo prensa talón neumático



OPTIONS → PLUS83H/D



PLUS83H/D
 PLUS83H con pressore sagomato WDK
 PLUS83H with WDK bead pressure device
 PLUS83H mit WDK-Wulstniederhalter
 PLUS83H avec outil de pression WDK
 PLUS83H con prensa talón WDK

G800A116

G1000A11



G1000A36

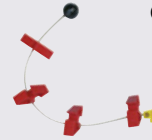

G1000A100K
(50 x kit)



G800A32



G800A49



G800A51



G800A114



G800A58



Helper  (for tilt back tyre changers) (for swing arm tyre changers)
 per smontagomme automatici per smontagomme a bandiera



PLUS91
 Dispositivo premi tallone pneumatico rotante
 Rotating pneumatic helper
 Pneumatischer Hilfsmontagearm
 Bras pousse-talon rotatif pneumatique
 Dispositivo neumático prensa talón rotatorio

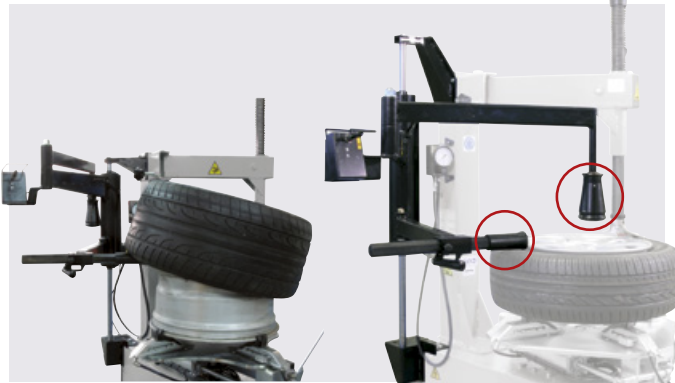

PLUS91N - PLUS91SE
 Dispositivo premi-alza tallone pneumatico con braccio rotante
 Pneumatic helper with rotating arm
 Pneumatischer Hilfsmontagearm auch mit Hebefunktion
 Bras pousse-et leve-talon rotatif pneumatique
 Dispositivo neumático prensa y levanta talón rotatorio



G800A69 → PLUS91SE
 Sollevatore ruota
 Wheel lift
 Radheber
 Élévateur de roue
 Elevador de rueda

Magic Cord

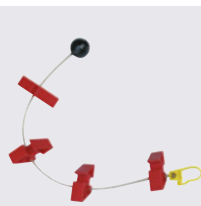
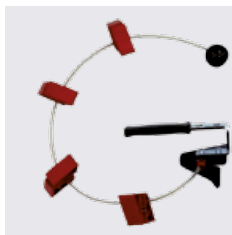

G1000A32
 Premitalone 24" con trazione.
 24" bead pushing device with pulling system.
 Wulstboy 24" mit Zugvorrichtung.
 Pousse-talon 24" avec traction.
 Prensa talón 24" con tracción.

G1000A36 (→ G1000A32)
 Extension (24" → 28")

Esempio di utilizzo
 How to use
 Gebrauchsbeispiel
 Exemple de utilisation
 Ejemplo de utilizzo

Bead Clamp



G84A13
 Morsetto blocca tallone.
 Bead-locking clamp.
 Wulstklemme.
 Etau bloque-talon.
 Mordaza bloquea talón.

Leva Alzatalloni / Bead Lever



G1000A52
 Leva alza tallone standard.
 Standard bead lever.
 Standardmontiereisen.
 Levier standard.
 Palanca levanta talón estándar.



G1000A11
 Leva alzatalone arcuata.
 Half moon bead lever.
 Halbmondmontiereisen.
 Levier demi-lune.
 Palanca levanta-talón en forma de "plátano".



G1000A13K (50 x kit) → G1000A52 - G1000A11
 Confezione protezioni leva alzataloni
 Bead lever protection package
 Satz Montagehebel-Alufelgenschutz
 Boite de protections levier
 Confección protecciones palanca levanta talones

Kit attacco rapido / Quick change kits



G800A70

Kit attacco rapido utensili (senza utensile)
 Kit for quick change of all tools (without tool)
 Schnellsteckvorrichtung (ohne Montagekopf)
 Kit raccord rapide (sans outil)
 Juego enganche rápido (sin útil)

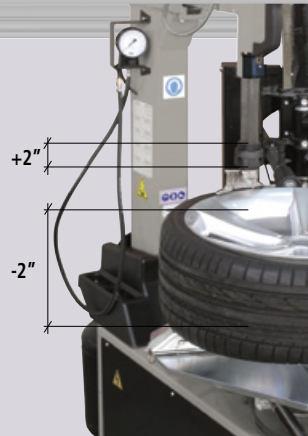

ATTENTION

Il G800A70 riduce il campo di lavoro di 2".
 G800A70 reduces max working range by 2".
 Der Einsatz vom G800A70 reduziert die max. Radbreite um 2".
 Le kit G800A70 réduit le hauteur maxi de 2".
 El juego G800A70 reduce la altura máxima de rueda de 2"

STANDARD → G800A70



Supporto a due posizioni
 Two position support
 Halter mit zwei Positionen
 Support pour deux têtes
 Doble soporte



Esempio di utilizzo
 How to use
 Gebrauchsbeispiel
 Exemple de utilisation
 Ejemplo de utilizzo

Accessori / Accessories → G800A70



G800A72

Utensile in plastica auto con mozzo per attacco rapido
 Car plastic tool with hub for quick coupling
 PKW-Kunststoffmontagekopf mit Adapter für Schnellsteckvorrichtung
 Tête synthétique VL avec moyeu pour raccord rapide
 Útil en plástico turismos con casquillo para enganche rápido



G800A74

Utensile in plastica moto con mozzo per attacco rapido
 Motorbike plastic tool with hub for quick coupling
 Motorrad-Kunststoffmontagekopf mit Adapter für Schnellsteckvorrichtung
 Tête synthétique moto avec moyeu pour raccord rapide
 Útil en plástico motos con casquillo para enganche rápido



G800A76

Utensile per ruote ATV con mozzo per attacco rapido
 Tool for ATV wheels with hub for quick coupling
 Montagekopf für ATV-Reifen mit Adapter für Schnellsteckvorrichtung
 Tête pour roues ATV avec moyeu pour raccord rapide
 Herramienta para ruedas ATV con casquillo para enganche rápido



G800A73

Utensile in plastica basculante con mozzo per attacco rapido
 Pivoting plastic tool with hub for quick coupling
 Freibeweglicher Kunststoffmontagekopf mit Adapter für Schnellsteckvorrichtung
 Tête basculante synthétique avec moyeu pour raccord rapide
 Útil pivoteante en plástico con casquillo para enganche rápido



G800A110

Utensile per cerchi con razze sporgenti con mozzo per attacco rapido.
 Tool suitable also for rims with protruding spokes with hub for quick coupling.
 Montagekopf geeignet auch für gewölbte Felgen mit Adapter für Schnellsteckvorrichtung
 Tête également approprié pour jantes bombées avec moyeu pour raccord rapide
 Útil idóneo para llantas con radios hacia fuera con casquillo para enganche rápido



G800A75

Terminale albero utensile per attacco rapido
 Shaft coupling for quick tool change
 Montagekopf-Adapter für Schnellsteckvorrichtung
 Terminal arbre outil pour raccord rapide
 Casquillo para enganche rápido

Tool Roller

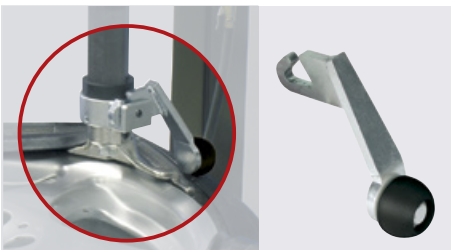

G800A18

Rullino premitallone per tutte le macchine in versione standard senza attacco rapido e G800A72.
 Bead pushing roller for all standard models without tool quick coupling and G800A72.
 Wulstniederhalte Rolle für alle Maschinen mit Montagekopf ohne Schnellsteckvorrichtung und G800A72.
 Rouleau pousse-talon. Pour tous les modèles version standard sans raccord rapide et G800A72.
 Rodillo prensa talón. Para todos los modelos en versión estándar sin enganche rápido y G800A72.

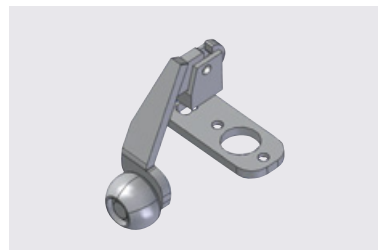

G800A18PS

Rullino premitallone per tutte le macchine in cui è montato l'attacco rapido con testina in plastica o acciaio.
 Bead pushing roller for all models with tool (plastic or steel) quick coupling.
 Wulstniederhalte Rolle für alle Maschinen mit Montagekopf mit Schnellsteckvorrichtung.
 Rouleau pousse-talon. Pour tous les modèles avec raccord rapide avec outil en acier ou synthétique.
 Rodillo prensa talón. Para todos los modelos que llevan el enganche rápido con útil de plástico o de acero.



Esempio di utilizzo
 How to use
 Gebrauchsbeispiel
 Exemple de utilisation
 Ejemplo de utilizzo

Gonfiaggio / Inflation



G84A1
Pistola di gonfiaggio.
Inflation gun.
Reifenfüllpistole.
Pistolet de gonflage.
Pistola de inflado.

G800A96
G800A14N

Kit gonfiaggio (pistola + valvola di gonfiaggio a pressione limitata).
Inflating kit (air gun + pressure reducer valve).
Satz Reifenfüllpistole mit Füllventil mit Druckminderer.
Kit gonflage (pistolet plus soupape de limitation de pression).
Kit inflado (pistolete + válvula limitadora de presión).



G84A2

Pistola di gonfiaggio Michelin.
Michelin inflation gun.
Michelin Reifenfüllpistole.
Pistolet de gonflage Michelin.
Pistola de inflado Michelin.

G84A15N

Kit gonfiaggio rapido CE Michelin (pistola + valvola di gonfiaggio rapido a pressione limitata).
Quick CE inflation kit Michelin (air gun + pressure-reduced quick inflating valve).
Satz Michelin-Reifenfüllpistole mit Schnellfüllventil mit Druckminderer.
Kit gonflage rapide CE Michelin (pistolet plus soupape rapide et lim. pression).
Kit pistola de inflado rapido Michelin CE (pistolete + válvula rapida y limitadora de presión).

Gonfiaggio a pedale / Pedal inflation

Dispositivo di gonfiaggio a pedale, completo di manometro e valvola di gonfiaggio rapido a pressione limitata.
Pedal-operated inflating device, with manometer and pressure-reduced quick inflating valve.
Reifenfüllvorrichtung mit Pedalbetätigung, mit Manometer und Schnellfüllventil mit Druckminderer.
Dispositif de gonflage à pédale, complet de manomètre et soupape de limitation de pression.
Dispositivo de inflado a pedal, completo de manómetro y válvula de inflado rápido a presión limitada.

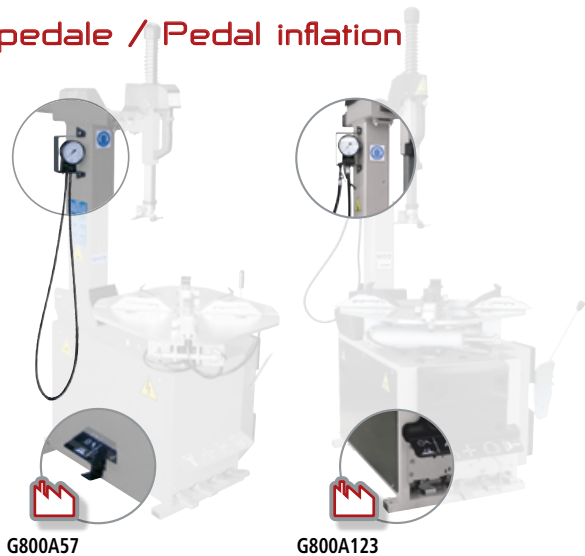

G800A57

G800A123

Intallamento / Bead-blaster

G800A80 → **G800A57**
Dispositivo di intallamento. Per smontagomme con gonfiaggio a pedale *Bead-blaster kit.*
For tyre changers with pedal inflation
Top-Reifenfüllvorrichtung. Für Montiergeräte mit Pedalbetätigt-Reifenfüllvorrichtung
Dispositif de positionnement talons.
Pour démonte-pneus avec gonflage à pédale
Dispositivo de entalonamiento. Para desmontadoras con inflado a pedal



Trattamento Aria / Air Treatment



G84A16
Lubrificatore / *Lubricator* / Ölter / *Lubrificateur* / Lubricador



G80A1
Filtro / *Filter* / Filter / *Filtre* / Filtro



G80A1R
Filtro con regolatore di pressione
Filter with pressure reducer
Filter mit Druckminderer
Filtre avec régulateur de pression
Filtro agua con regulador de presión



G800A13
Regolatore di pressione
Pressure reducer
Druckminderer
Régulateur de pression
Regulador de presión

Moto / Bike



G84A5 (4 x kit) → 18" 20" OLD 22" OLD
G800A99 (4 x kit) → 20" NEW 22" NEW
G800A107 (ex G84A34) (4 x kit) → 24" 26"
Griffe per ruote moto con montaggio rapido (+5" da esterno).
Fast-fit motorcycle wheel clamps (+ 5" from outside).
Mobile Motorradspannklauen (+5" von aussen).
Griffes pour roues de moto avec montage mobile (+5" de l'extérieur).
Garras para ruedas de moto con montaje móvil (+5" del exterior).

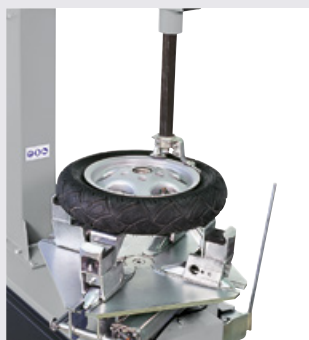

G84A24 (4 x kit) → G84A5
G800A111 (4 x kit) → G800A99, G800A107
Adattatori per riduzione presa griffe (-2", -4" da esterno).
Adaptors for reducing clamping capacity (-2", -4" from outside).
Adapter für Motorradspannklauen (-2", -4" von aussen).
Adaptateur de réduction de la prise (-2", -4" de l'extérieur).
Adaptadores para reducción para garras (-2", -4" del exterior).



G800A78
Paletta stallonatore per ruote moto, di serie su versioni BIKE.
Bead-breaker adaptor for motorcycle wheels, standard on BIKE versions.
Abdrückschaufel für alle Modelle standard auf BIKE.
Détalonneur pour roues moto, d'origine sur versions BIKE.
Paleta destalonadora para ruedas de moto, de serie en los modelos BIKE.

20" NEW
22" NEW
Griffe rialzate (da luglio 2013)
Higher clamps (from July 2013)
Höhere Spannklauen (ab Juli 2013)
Griffes hautes (de Juillet 2013)
Garras altas (desde Julio 2013)



18"
20" OLD
22" OLD
Griffe standard
Standard clamps
Standard Spannklauen
Griffes standard
Garras estandar

Protections / Protezioni



Inserto in plastica anti-slittamento
Anti-skid plastic insert
Kunststoffeinlage für Rutschfestigkeit
Insert plastique anti-glissement
Inserto en plástico anti-deslizante

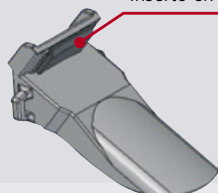

G800A5 (4 x kit) → 18"
→ 20" OLD
→ 22" OLD

G800A98 (4 x kit) → 20" NEW
→ 22" NEW

G800A6 (4 x kit) → 24"
→ 26"

G800A5K - Kit 10 x G800A5

G800A98K - Kit 10 x G800A98

G800A6K - Kit 10 x G800A6

Set protezioni griffe - *Clamp protection kit* - Spannklauen-Alufelgenschutz -
Kit protections de Griffes - Juego protecciones garras



G800A7 (4 x kit) → 30"
Set protezioni griffe
Clamp protection kit
Spannklauen-Alufelgenschutz
Kit protections de Griffes
Juego protecciones garras
G800A7K - Kit 10 x G800A7

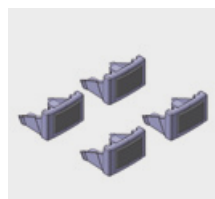

G800A54 (4 x kit) → G800A7
Set protezioni per presa dall'interno
Protection kit for inside clamping
Alufelgenschutz für innere Spannung
Protections bloquage de l'intérieur
Protecciones bloqueo del interior
G800A54K - Kit 10 x G800A54



G800A117 (2 x kit) QUICK INSERT
Set protezioni utensile
Tool protection kit
Satz Montagekopf-Alufelgenschutz
Kit de protection outil
Juego protecciones útil
G800A117K - Kit 10 x G800A117



G800A8 (2 x kit) → LEVERLESS
Set protezioni utensile
Tool protection kit
Satz Montagekopf-Alufelgenschutz
Kit de protection outil
Juego protecciones útil
G800A8K - Kit 10 x G800A8

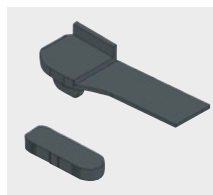

G84A17 (2 x kit) → G800A110
Set protezioni utensile
Tool protection kit
Satz Montagekopf-Alufelgenschutz
Kit de protection outil
Juego protecciones útil
G84A17K - Kit 10 x G84A17



G800A11
Protezione paletta stallonatore
Bead breaker blade protection
Abdrückschauflerschutz
Protection détalonneur
Protección paleta
destalonadora
G800A11K - Kit 5 x G800A11

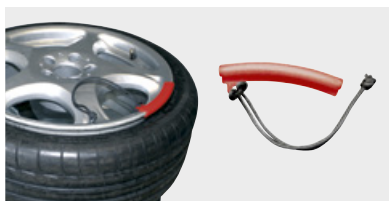

G800A32
Protezione tallone per pneumatici
"Run Flat"
Run Flat bead protection
Felgenhornwulstschutz für
"Run Flat-Reifen"
Protection talon pour pneus "Run Flat"
Protección talón para neumáticos
"Run Flat"



G1000A100K (50 x kit)
Confezione di protezioni tallone RFT
(direttiva WDK).
Bead protections for RFT (WDK standard).
WDK-Kit.
Boîte de protections talon RFT
(norme WDK).
Juego de protecciones talón ruedas RFT
(norma WDK).



G800A122 (8 x kit)
G800A122K (40 x kit)
Punte sostituibili
Renewable spikes
Austauschbaren Haltekörner
Pointes remplaçables
Puntas reemplazables

Bead Blaster Protection Protezione Intallamento



G800A100 → PLUS83, PLUS91, 91N, 91SE
Protezione utilizzatore raccomandata durante
l'intallamento e il gonfiaggio.
*User protection recommended during bead
blasting and inflation.*
Empfohlener Benutzerschutz während der
Reifenbefüllung.
*Protection utilisateur pendant le gonflage et le
positionnement des talons.*
Protección usuario durante entallamiento y inflado.

Kit Senza-Leva / Leverless Device



G800A81 → xx441
 G800A82 → xx641, xx645
 G800A83 → xx441 + G800A63
 G800A84 → xx645 + G800A68
 G800A85 → xx641 + G800A56

Per smontagomme automatici.
 For tilt back tyre changers.
 Für Automatische Reifenmontiergeräte.
 Pour démonte-pneus automatiques.
 Para desmontadoras automaticas.



G800A87 → xx246
 Per smontagomme a bandiera
 For swing arm tyre changers
 Für Halbautomatische-Reifenmontiergeräte
 Pour démonte-pneus semi-automatiques
 Para desmontadoras sémi-automáticas

Vari / Various



G800A35
 Sollevatore pneumatico ruote.
 Pneumatic wheel lifter.
 Pneumatischer Radheber.
 Élévateur pneumatique de roue.
 Elevador neumático ruedas



G800A37 (3,5 kg / 8 lb)
 Pasta di montaggio.
 Mounting grease.
 Montagepaste.
 Pâte de montage.
 Jabón profesional.
 NOTE: 8 x carton
 160 x pallet



G800A38
 Pennello.
 Brush.
 Schmierpinsel.
 Pinceau.
 Brocha.



G800A63 → xx441
 G800A56 → xx641
 G800A68 → xx645

Movimento pneumatico dell'utensile.
 Pneumatic movement of the tool.
 Pneumatische Werkzeugbewegung.
 Actionnement pneumatique de l'outil.
 Movimiento neumático de l'util.



G800A77
 Vaschetta porta-oggetti
 Storage tray
 Ablagemöglichkeit
 Support accessoires
 Portaobjetos

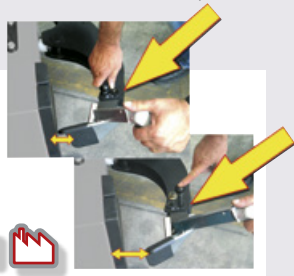

G800A26
 Paletta stallonatore con regolazione inclinazione.
 Bead-breaker adaptor with tilting adjustment.
 Abdrückschaufel mit einstellbaren Abdrückwinkel.
 Détalonneur avec inclinaison réglable.
 Pala destalonadora con regulación inclinación.



G800A101 - G800A102
 Azionamento stallonatore sulla pala
 Bead breaker control by lever
 Hebel-Abdrückschaufelbetätigung
 Commande d'actionnement par levier
 Accionamiento destalonador sobre la pala



G1000A115
 Limitatore corsa stallonatore
 Bead-breaker stroke limiter
 Abdrückschaufelbegrenzer
 Limiteur de course détalonneur
 Limitador de carrera destalonador